

MEIKO M-iClean PF

Utensil washer

Installation instructions

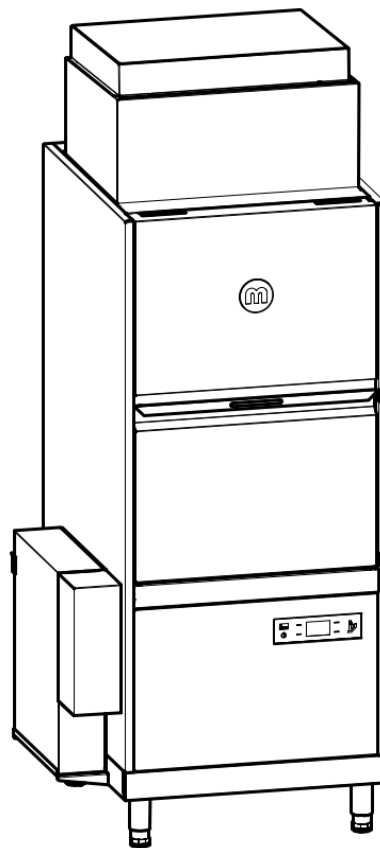

For the types in the series: M009DWFL10M1-****



Read before assembling the machine!

Contents

1	NOTICE REGARDING INSTALLATION INSTRUCTIONS	3
1.1	Product identification	3
1.2	Presentation conventions	3
1.2.1	<i>Safety symbols in the instructions</i>	3
2	SAFETY	4
2.1	General safety instructions	4
3	TRANSPORT	5
3.1	Checking the condition at delivery	5
3.2	Unpacking	6
4	TECHNICAL DATA	6
5	DIMENSIONAL DRAWINGS AND CONNECTION DIMENSIONS	7
6	INSTALLATION	10
6.1	Requirements to the electrical connection	10
6.2	Requirements for the fresh water connection Requirements for the fresh water connection	11
6.3	Requirements for the waste water connection	12
6.4	Building ventilation system	12
7	ASSEMBLY	13
7.1	Align machine feet	13
7.2	Install on a plinth	13
7.3	Fit AirConcept (heat recovery)	14
7.4	Connect dosing pipes	18
7.5	Install solid substance dosing (optional)	19
7.6	Connect external GiO MODULE (optional)	21
7.7	Connection	27
7.7.1	<i>Connect waste-water line</i>	27
7.7.2	<i>Connect fresh water line</i>	27
7.7.3	<i>Connect electrically</i>	27
8	COMMISSIONING	27
9	INDEX	28

1 Notice regarding installation instructions

1.1 Product identification

These installation instructions are valid for the product series
MEIKO M-iClean PF (M009DWFL1M1-10).

1.2 Presentation conventions

Warnings

 **DANGER** – indicates an imminently hazardous situation which, if not avoided, will result in serious injury or death.

 **WARNING** – indicates a potentially hazardous situation which, if not avoided, could result in serious injury or death.

 **CAUTION** – indicates a possible hazardous situation which, if not avoided, could result in minor or moderate injury or damage to property.

Notices on use







Note – indicates useful and important information about the product or its use.

Notes on using the document:

- A bullet point (•) designates an action step.
- Numerals (1.) designate several action steps that must be executed in the specified sequence.
- Position numbers in the text that refer to position numbers in illustrations are shown in parentheses:
(1) Position number 1 in the illustration
- The text is always below the illustration and refers to it until a new image follows.

1.2.1 Safety symbols in the instructions

	Read document		Potential equalisation connection
	Caution		Manufacturer

2 Safety

2.1 General safety instructions

Authorisation for assembly/installation and commissioning

- Assembly may only be performed by a specialist company. Installation may only be carried out by licensed electricians/plumbers.
- Commissioning may be performed only by a service technician authorised by MEIKO.

Installation site

- Only furniture that is resistant to condensation should be used in the vicinity of the dishwashing machine.
- Observe the installation conditions (see page 6).

Electrical safety

- The electrical safety of this appliance is only ensured if it is connected to a properly installed protective earth conductor system. It is very important to verify this fundamental safety feature. If in doubt, have the local wiring checked by an electrician. The manufacturer cannot be held liable for damage caused due to the protective earth conductor being missing or disconnected (e.g. electric shock).
- Modifications to electrical systems during installation may only be carried out by a qualified specialist.
- Where discharge currents exceed 10 mA, the use of an RCD is not recommended.
False alarms restrict machine availability. MEIKO expressly excludes any liability for damages caused by improper connection of the machine.
This includes any costs in connection with services due to said connection, e.g. processing complaints or claims due to:
 - Triggered RCD
 - Automatic shut-down of the supply when continuity is lost in the protective conductor (EN 60204-1 Chap. 8)

Dosing agent

- Take care when handling dosing agents (water softeners/rinsing aids and detergents). They are corrosive substances. Observe the applicable safety regulations! Use safety eyewear and protective gloves. Observe the manufacturer's safety instructions and safety data sheets when handling dosing agents.
- Do not inhale vapours from dosing agents.

General

- Only use the dishwashing machine in its original condition without independent changes and in a technically perfect condition.
- Do not sit or stand on the opened wash chamber door. This could damage the appliance and cause injury.
- Do not place any objects on the dishwashing machine.

3 Transport

⚠ WARNING – danger of injury due to machine tipping

- Only qualified personnel may carry out transport works.
- Please note safety notices on the packaging.
- Always transport the machine on a wooden frame only.
- Wear protective gloves and safety shoes.

The packaging is specifically designed to allow the machine to be moved safely and securely using a pallet jack. For safe transport, the dishwashing machine is supported by a special square timber frame.

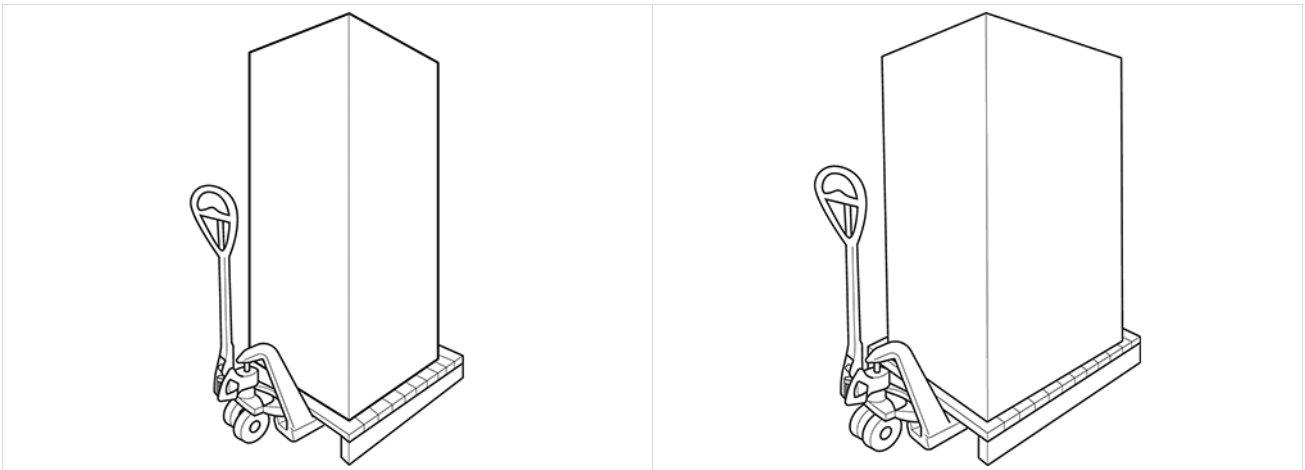

- Execute transport carefully.
- Observe the instructions for safe transport on the packaging.
- Open packaging using a suitable tool.
- Unpack dishwashing machine only once transport is completed.

3.1 Checking the condition at delivery

- Check that the delivery is complete immediately after receiving it by comparing it with MEIKO's order confirmation and/or the delivery note.
- If applicable, submit a claim for any missing parts immediately to the freight forwarder and notify MEIKO.
- Check the machine for transportation damage.



Note

If there is any suspicion of transportation damage, the shipping company and MEIKO must be informed immediately in writing. Photograph any damaged parts and send the pictures to MEIKO.

3.2 Unpacking

1. Detach the plastic straps from the cardboard.
2. Remove the cardboard.
3. Remove the anti-slip devices by the feet from the pallet.
4. Have two people carefully push the machine off the pallet so as not to damage the feet.

Removing the protective films

After unpacking the product, remove the protective films from the housing parts and clean the stainless steel surfaces with a suitable detergent.

4 Technical data

Environmental conditions	
Operating temperature	5–40°C
Relative humidity	< 95%
Storage temperature	5–40°C
Maximum height of the installation site above sea level	2000 m
Net weight	
M-iClean PF-S	226 kg
Noise emission	
Noise level in the workplace LpA	≤ 70 dB (A)
GiO MODULE	
Dimensions (W x D x H)	143 x 660 x 600 mm
Connection cable from module to machine	3 m

5 Dimensional drawings and connection dimensions

MEIKO M-iClean PF-S Standard and solid substance dosing option

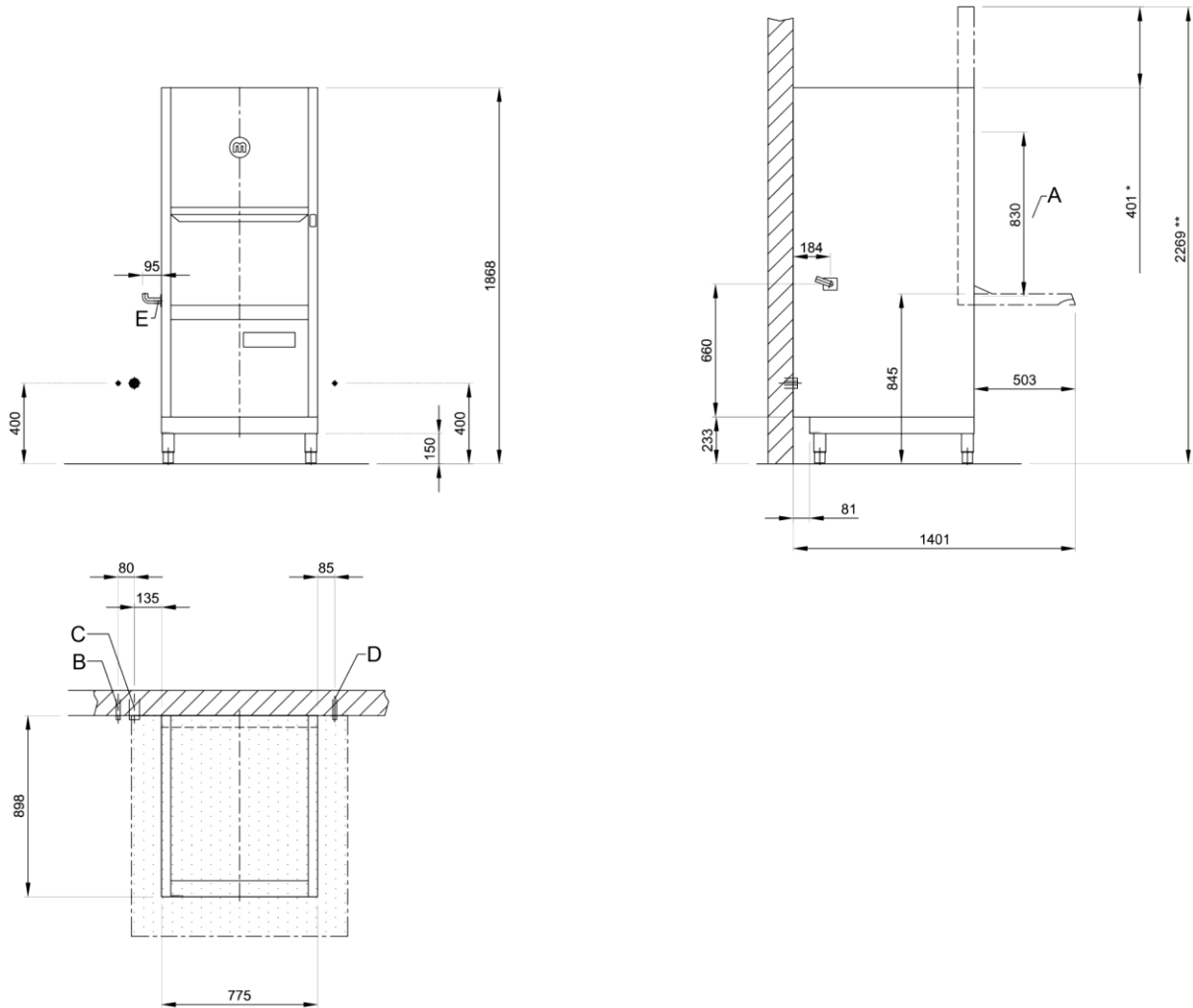

*	Max. 500 (door folded down)
**	Max. 2369 (door folded down)
A	Entry height
B	Fresh water supply line
C	Drain
D	Electrical supply pipe to the machine
E	Connection for solid detergent dosing unit on site (optional)

MEIKO M-iClean PF-S with AirConcept (heat recovery)

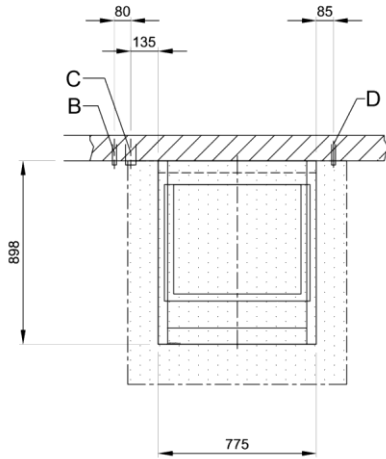
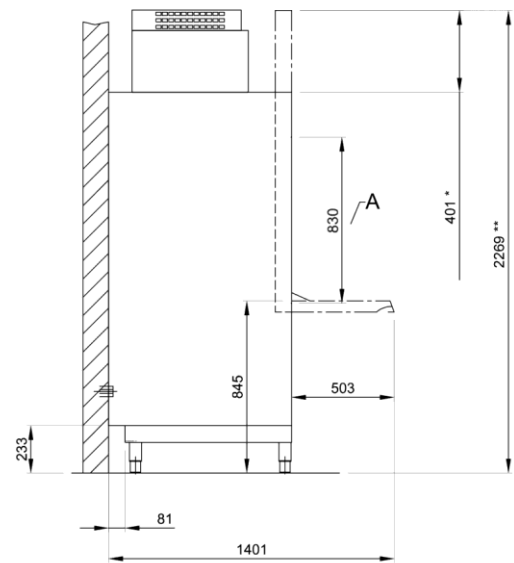
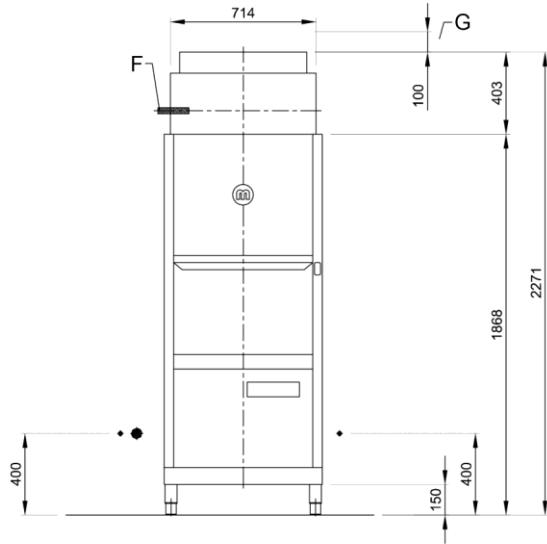

*	Max. 500 (door folded down)
**	Max. 2369 (door folded down)
A	Entry height
B	Fresh water supply line
C	Drain
D	Electrical supply pipe to the machine
F	Separation
G	Installation clearance

MEIKO M-iClean PF-S with GiO MODULE (optional)

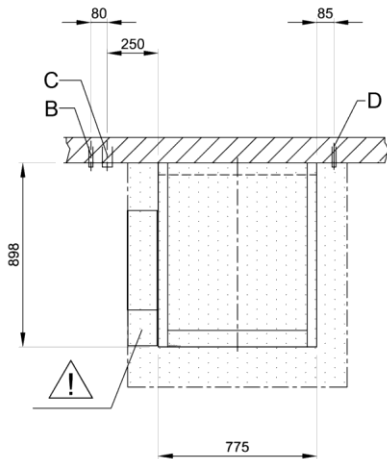
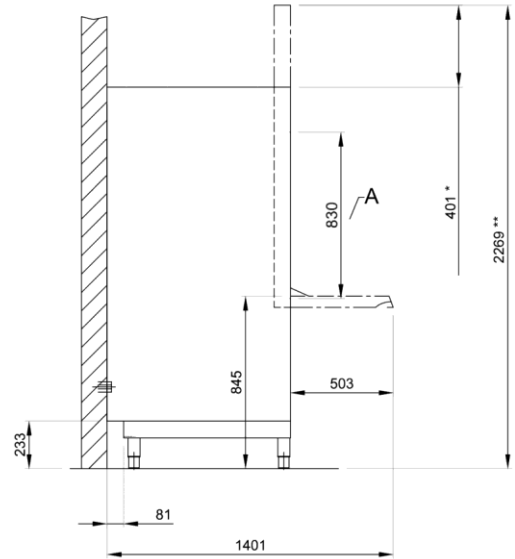
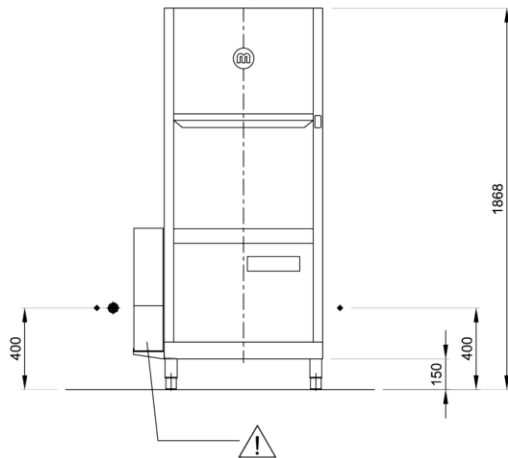

*	Max. 500 (door folded down)
**	Max. 2369 (door folded down)
A	Entry height
B	Fresh water supply line
C	Drain
D	Electrical supply pipe to the machine
	GiO MODULE on bracket (W x D x H) 143 x 660 x 600 mm

Country-specific deviations are possible. Binding specifications can be found on the order-specific dimension sheet.

6 Installation

6.1 Requirements to the electrical connection

Electrical connection must be carried out in accordance with the locally applicable regulations (e.g. HD 60364-1/IEC 60364-1/VDE 0100-100) so the machine can be connected to the mains supply in accordance with the installer's regulations. However, national installer's regulations may differ. The machine and accessory appliances are intended for permanent connection to the on-site power supply and the on-site protective equipotential bonding and have been tested accordingly before being brought to market.

Fuse protection

- Set up the machine according to the local conditions and according to the rated current (see rating plate) as a separately fused circuit (final circuit). Take note of the available connection variants.

Main switch/mains connection cable

- Install a main switch with all-pole disconnection from the mains in accordance with the installer's regulations in the permanently installed on site installation.
- The main switch must be easily accessible for the operating personnel.
- The contact opening width must correspond to overvoltage category III in each pole.
- Mains power cables, unless part of the standard product scope of supply, must be oil-resistant, sheathed, flexible cables no lighter than a normal polychloroprene-sheathed cable (or other equivalent synthetic elastomer) with the marking 60245 IEC 57.
- Refer to the circuit diagram or the data sheet of the main switch for technical data such as torque and stripping length.

Electrical safety

- The electrical safety of this machine is only ensured if it is connected to a properly installed protective conductor system. It is very important to verify this fundamental safety feature. If in doubt, have the building wiring checked by an electrician.
- Carry out the protective measures as well as the connection of the equipotential bonding in accordance with the regulations of the local power supply companies as well as the locally applicable regulations.
- As an alternative to equipotential bonding, the operator can, acting on its own responsibility, use a mains-side residual current device (RCM or RCD) for protection in the event of direct or indirect contact. A type "A" according to IEC/EN 60755 is sufficient.

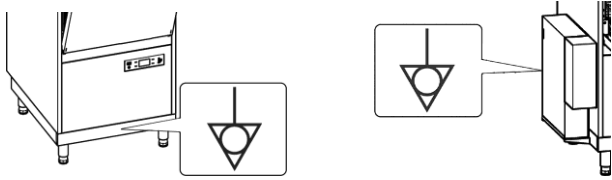
Electrical connection	
Voltage	See rating plate
Total connected load	
Fuse protection	
Equipotential bonding	 <p>Located in the middle behind the lower front panel and on the rear of the GiO-MODULE (optional).</p>

Electrical connection	
Mains connection terminal strip	5-pin (with neutral conductor) 4-pin (without neutral conductor)
Special national conditions	USA/Canada: The machine must be installed in accordance with local regulations. In the absence of any such regulations, install the machine in accordance with the applicable requirements in the National Electrical Code, NFPA 70, Canadian Electrical Code (CEC), Part 1, CSA C22.1 and the Standard for Ventilation Control and Fire Protection of Commercial Cooking Operations, NFPA 96.

6.2 Requirements for the fresh water connection

- Fresh water connections must comply with the locally applicable regulations (e.g. DIN EN 1717). Install a shut-off device on site in each fresh water supply line; the device must be easily accessible for the operating personnel. This dishwashing machine is installed as a fully functional unit and only needs to be connected to the local power and water supply.
- Only connect the dishwashing machine using suitable hoses and seals. Hoses may only be used if in an intact condition!
- When replacing an old machine with a new one, make sure that the existing feed hose is exchanged for the new feed hose supplied with the machine.
- The hoses have a 3/4 inch thread for connecting to the on-site shut-off valves.

Fresh water connection	
Water quality	From a microbiological perspective, the fresh water must be of drinking water quality. This also applies to treated water.
Air gap	Type AB according to DIN EN 1717 or DIN EN 61770 with pressure booster pump after air gap
Equipment	Solenoid valve/leakage detector switch
Flow rate	Min. 8.0 l/min
Minimum flow pressure With GiO MODULE	60 kPa / 0.6 bar before the solenoid valve 100 kPa/1 bar
Maximum pressure	500 kPa/5.0 bar (1000 kPa in DK, SV, NO, FI)
Shut-off valve and fine filter to be provided on site	≤ 25 µm
Max. feed water temperature With GiO MODULE With exhaust air heat recovery With VZ20 DELTA Soft water softener	60°C 35°C 20°C 50°C
Special national conditions	In the case of SVGW (Switzerland) and other countries, a type EA safety device is also required upstream of the connection hose. Higher maximum pressure in Denmark, Sweden, Norway, Finland (see above)

Fresh water limit values when operating a reverse osmosis module	
Designation	Value
Conductivity	70 – 1000 µS/cm
Water hardness	0 – 28 °dH
Feed water temperature	Min. 1°C to max. 35°C (cold water connection)
Minimum flow pressure	100 kPa (1 bar)
Maximum pressure	500 kPa (5 bar)
Free from particles	> 10 µm
Iron	< 0.1 mg/l
Manganese	< 0.04 mg/l
Chlorine (free chlorine)	< 0.1 mg/l (standard membrane)
Chlorine (free chlorine)	≥ 0.1 to ≤ 2.0 mg/l (more chlorine resistant membrane)
Potassium permanganate	< 10 mg/l
Silicic acid	< 10 mg/l

6.3 Requirements for the waste water connection

- Waste water connections must comply with DIN EN 1256 and the locally applicable regulations.

Waste water connection	
Drain pump present?	Yes
Grease separator	Observe local regulations
Maximum drain height above finished floor	With GiO MODULE: 650 mm Without GiO MODULE: 700 mm
Connecting hose extending from the machine	2 m
Special national conditions	Australia: The drain hose must be connected so that it is waterproof with a drain fitting in accordance with AS 1589 AS 2887 and a sanitary waste water pipe or sanitary waste water fitting in accordance with AS/NZS 1260

6.4 Building ventilation system

- The building ventilation system must comply with the locally applicable regulations (e.g. EN 16282), and must always be watertight and corrosion-resistant. The exhaust air may contain small amounts of aerosols, therefore discharge exhaust air through suitable exhaust air zones or exhaust air hoods. If the exhaust air is discharged into the surrounding room, adjust the discharged volumetric air flow.

7 Assembly

7.1 Align machine feet

1. Place the machine at its destination using the pallet jack.

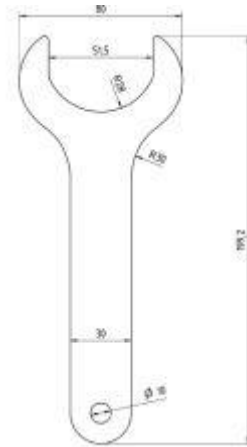

2. Relieve the pressure on the foot and adjust it to the desired height using a suitable spanner. Do not use pliers!

3. To adjust the foot, use a short spanner with a width across flats of 50.



4. Check the level of the machine using a spirit level.

7.2 Install on a plinth

1. Lift the machine with the pallet jack and unscrew the machine feet.

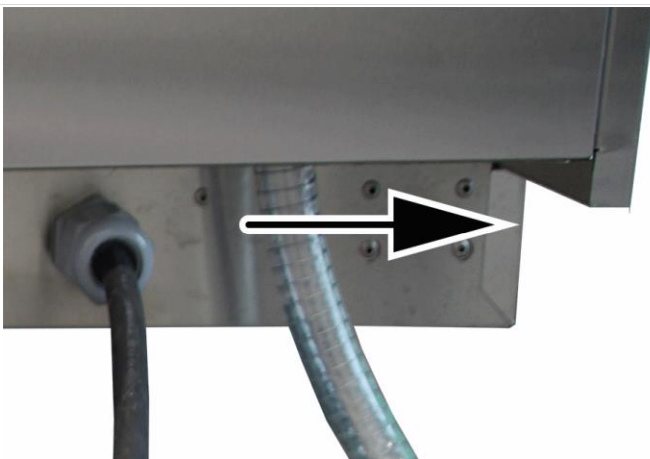

2. Guide the lines with cable protection through the opening on the desired side.
3. Place the machine on the plinth using the pallet jack.
4. To align the machine, screw M10 screws from the inside into the nuts of the machine feet.
5. For fine alignment, if necessary, shim on the front side.

7.3 Fit AirConcept (heat recovery)

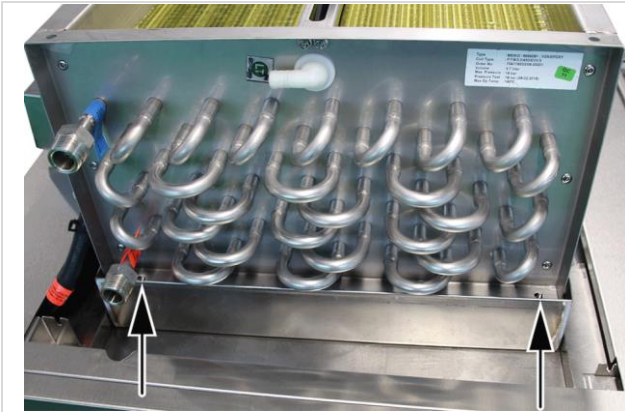

1. Place the heat exchanger unit on the dishwashing machine and insert the threaded bolts on the dishwashing machine through the holes in the heat exchanger unit. Position the connections for the hoses on the left-hand side.



2. Secure the heat exchanger unit with 4 M5 safety nuts.

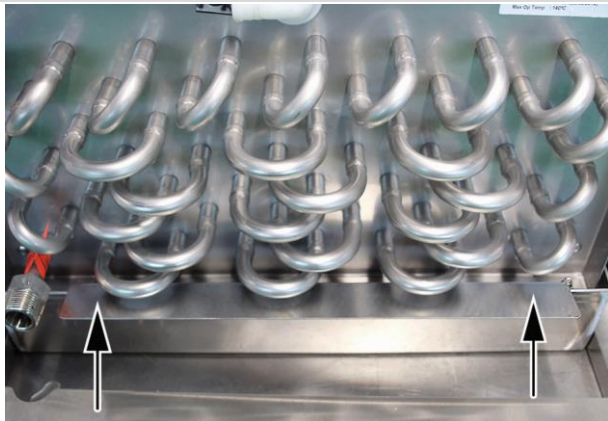

3. Attach the bracket on the left side. Ensure that the bracket is correctly fitted.

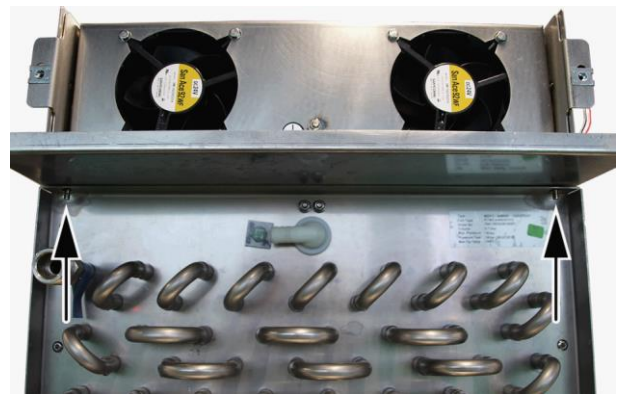

4. Place the fan unit on the heat exchanger unit and guide the threaded bolts of the fan unit through the holes in the heat exchanger unit.



5. Secure the fan unit with 4 M5 safety nuts.



6. Slide the four clips onto the holes on the sides of the fan unit.

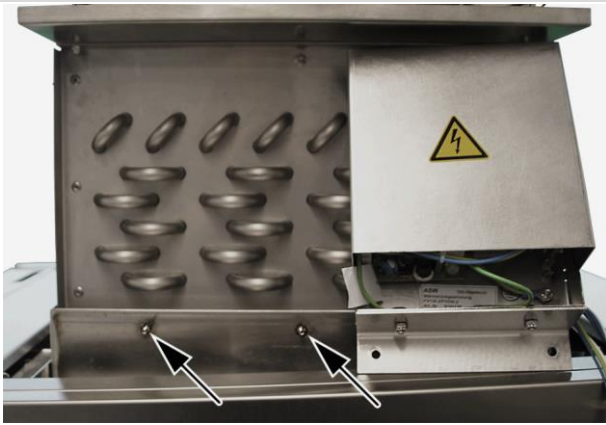

7. Fit the electrical box on the right side and insert the threaded bolts through the holes in the electrical box.

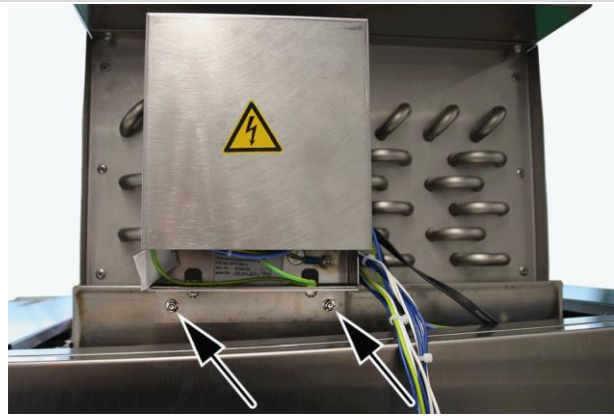

8. Secure the electrical box with 2 M5 safety nuts.

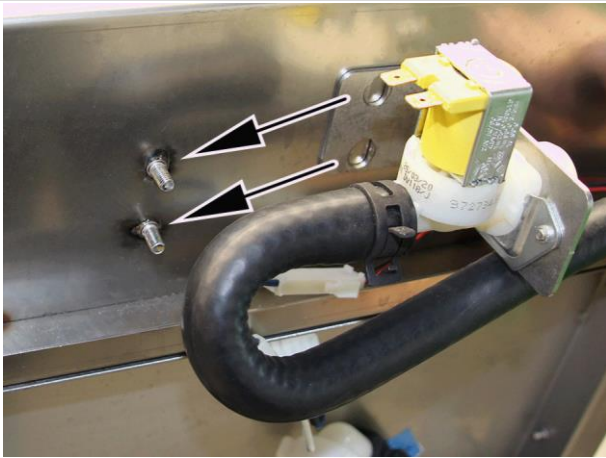

9. Fit the solenoid valve on the back and pass the threaded bolts through the holes in the bracket.



10. Secure the solenoid valve with 2 M5 safety nuts.



11. Connect the hoses and tighten them by hand. Secure the upper hose on the front with a spring band clamp.
When fitting the hoses, pay attention to the colour markings.

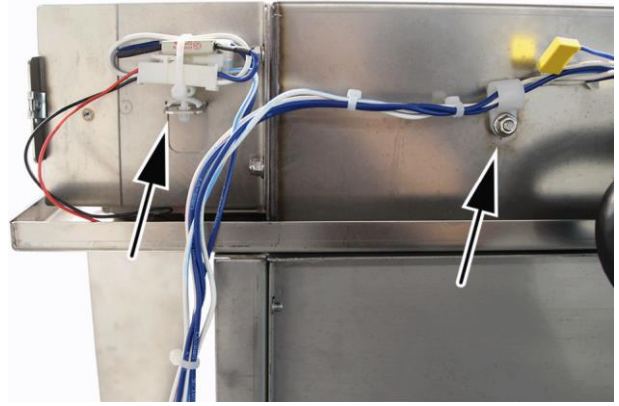
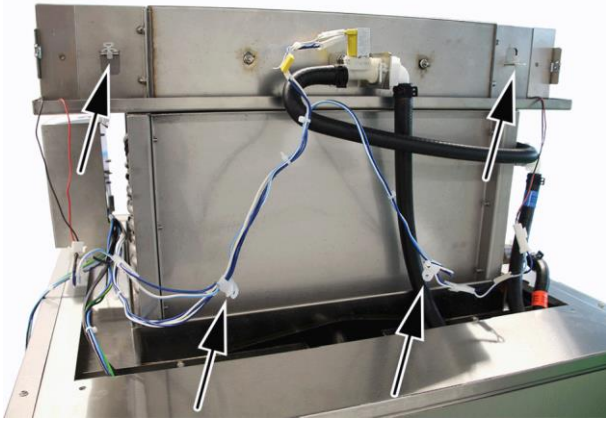

12. Lay the cables on the machine according to the cable length and secure them with the enclosed clamps.

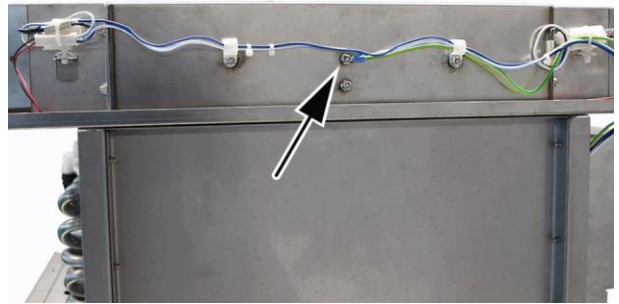
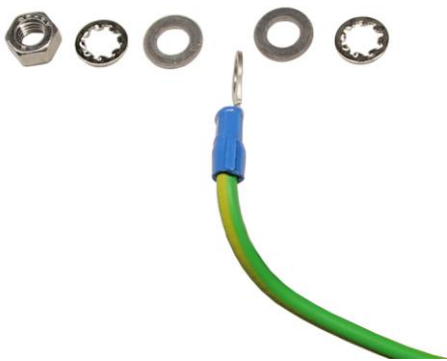

13. Attach the protective conductor on the front with connection plan Z.

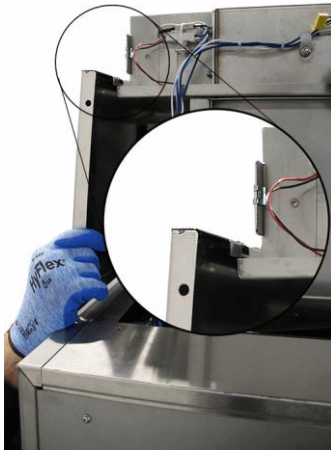

14. Slide in the heat exchanger unit casing from the front and hook it onto the sides.



15. Secure the heat exchanger unit casing on the front with 2 self-tapping screws.

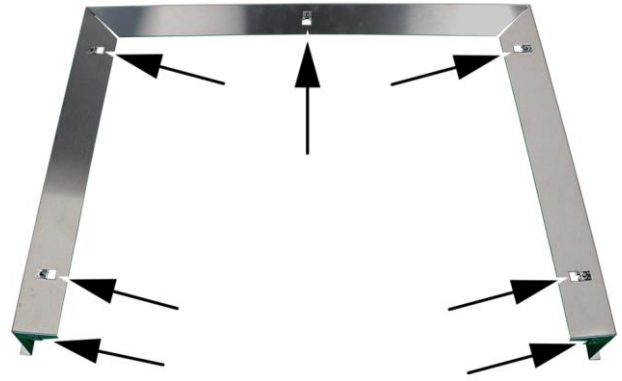
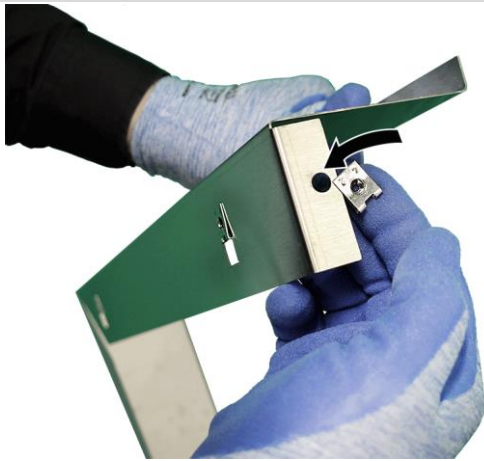

16. Slide the 7 clips onto the holes in the casing for the fan unit.



17. Push in the fan unit casing from the front. Secure the casing with 4 self-tapping screws per side and 2 self-tapping screws on the front.

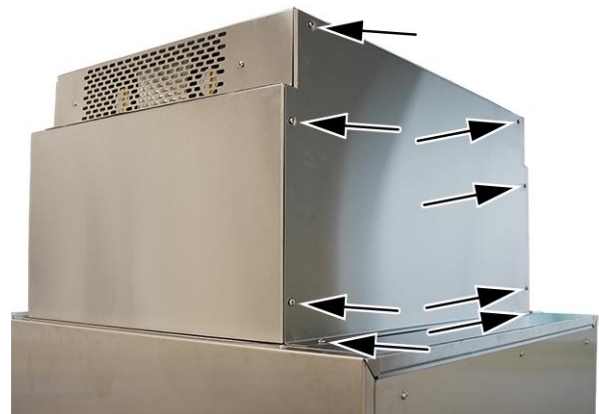

18. Hook in the rear panel at the top and secure it with 8 self-tapping screws.

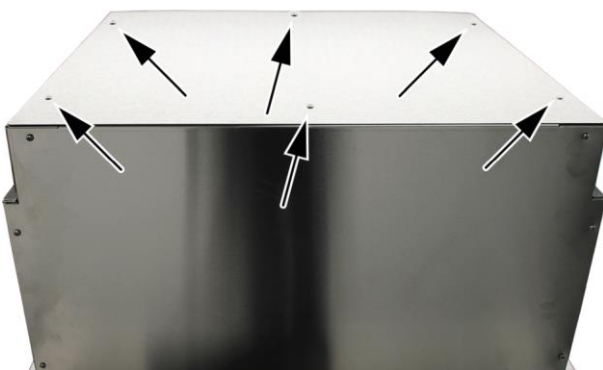

19. Put on the cover and secure it with 6 self-tapping screws.

7.4 Connect dosing pipes

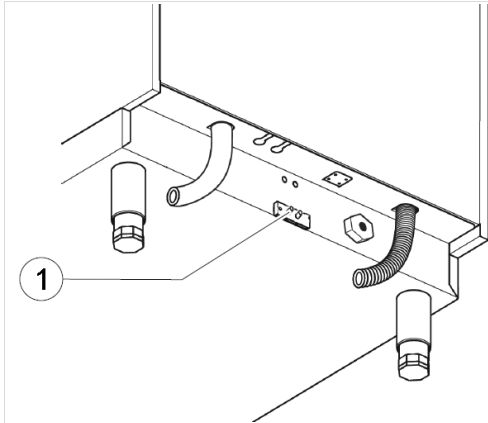

The connections for detergent (white), rinse aid (blue) and the third dosing agent (optional) are located in the middle at the bottom of the back of the machine (1).

1. Connect the hoses with the suction lances according to the colours and secure them with a collar clamp.



2. Punch a hole in the centre of each of the detergent and rinse aid canister covers.

Note: The hole must be large enough for pressure equalisation to take place.



3. Guide the suction lances into the canisters and through the hole in the canister cover. Screw on the canister covers tightly.



4. Connect the transparent hose to the suction lance in the white canister for detergent. To secure in place, squeeze the clamp at the connection and release it at the correct position.



5. Connect the blue hose to the suction lance in the blue rinse aid canister. Tighten the clamp on the connection.

6. Place the canisters for detergent and rinse aid according to the environment.

7.5 Install solid substance dosing (optional)



Note

- The dosing point can be attached on the left or right side of the machine. The attachment for the right side is shown below as an example. When mounted on the left side, the representations are to be understood as mirror images.
- Where machines have a GiO MODULE mounted on the side, the dosing point must be installed on the side opposite the side with the GiO MODULE.

Position of the hole in the side wall

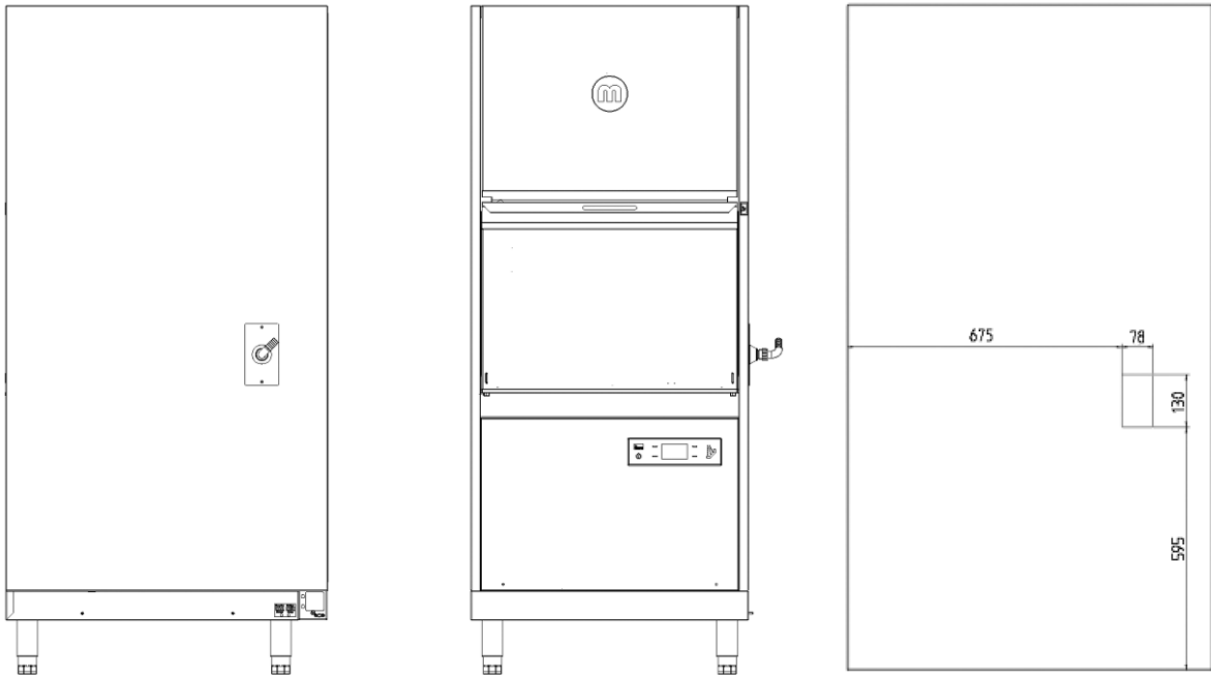



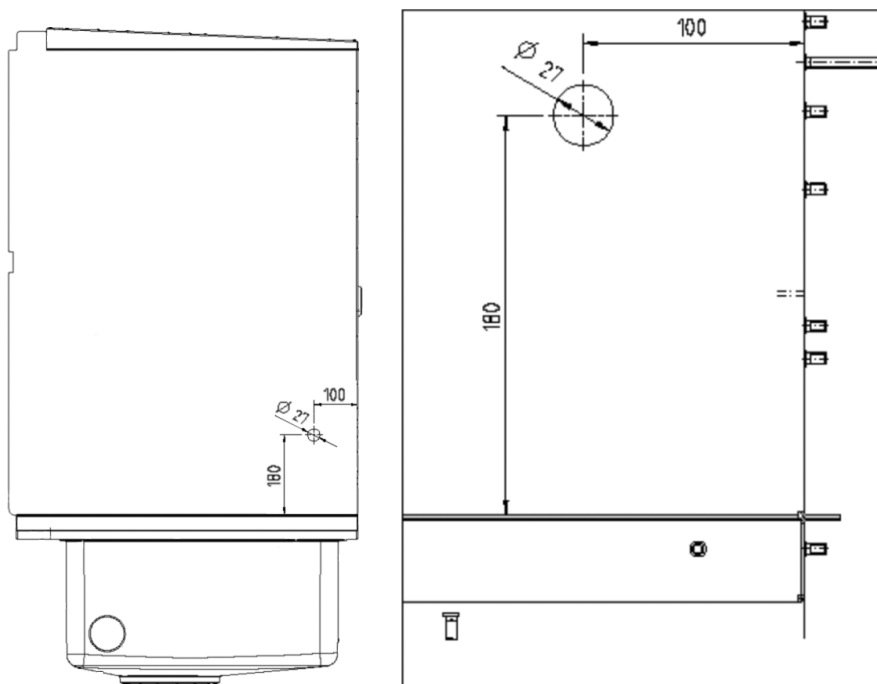

Position of the hole in the wash chamber

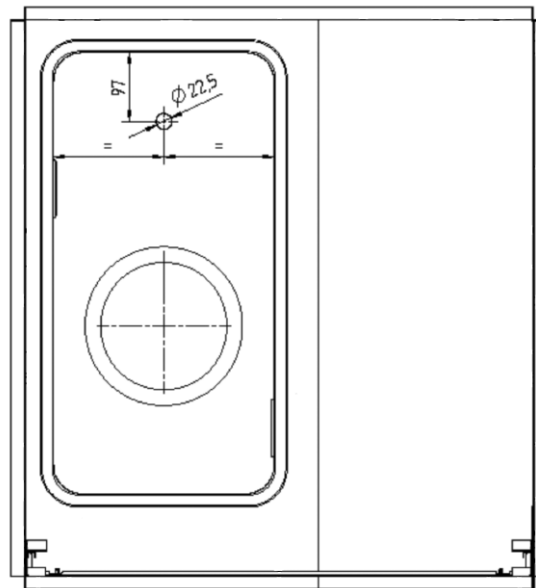

Position of the electrode to measure conductivity

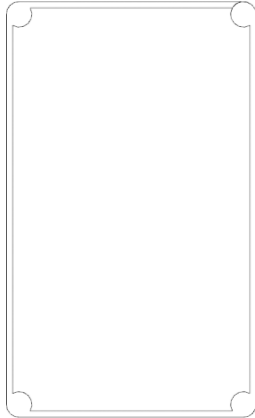

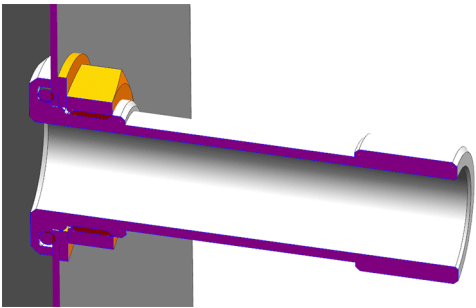
Install dosing point

<p>1. Select the side for the dosing point.</p>	<p>2. Remove the side wall.</p>
	
<p>3. Place the rectangular cut-out on the side wall. To easily separate the cut-out, drill a $\text{Ø } 8 \text{ mm}$ hole in each corner.</p>	<p>4. Drill the hole for the dosing connection on the wash chamber.</p>
	
<p>5. Fit the dosing connection with O-ring, washer and hexagon nuts on the wash chamber. 6. Install the side wall.</p>	<p>7. Push the cover plate with grommet over the dosing connection and align it. Mark the position of the 2 threaded bolts for securing the cover plate.</p>



8. Weld on the 2 threaded bolts (M5x8).

9. Mount the cover plate with washer and cap nut (M5). Attach the 90° hose connection.

10. Remove the tank cover sieve and the filter.

11. Drill the hole for the measuring electrode at the tank bottom. The hole diameter may change depending on the conductivity probe to be installed.



12. If the solid dosage is not used, the hole for the dosing connection in the wash chamber must be closed with the sealing plug, the O-ring and the hexagon nut. The grommet of the cover plate must be replaced with the sealing plug.

7.6 Connect external GiO MODULE (optional)



Note

The GiO-MODUL can be attached to a console on the dishwasher or connected as a free-standing unit.

Mounting on retaining plate

1. Loosen the 6 screws of the cover of the GiO MODULE and carefully remove the cover. The protective conductor is mounted on the inside of the cover. Make sure that the cable is not damaged.

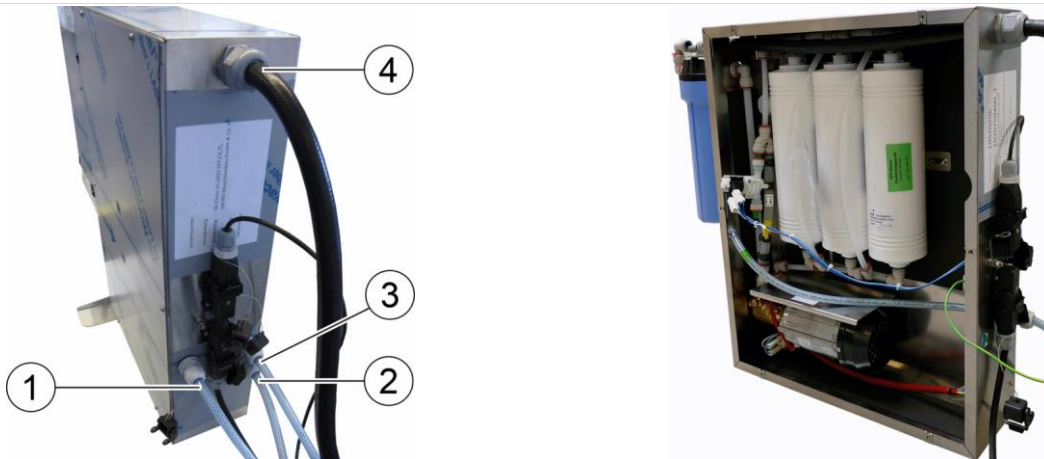

2. Guide the fresh water supply line (4) and the transparent fabric hoses for permeate recirculation (1), permeate (3) and concentrate (2) through the side opening in the casing.

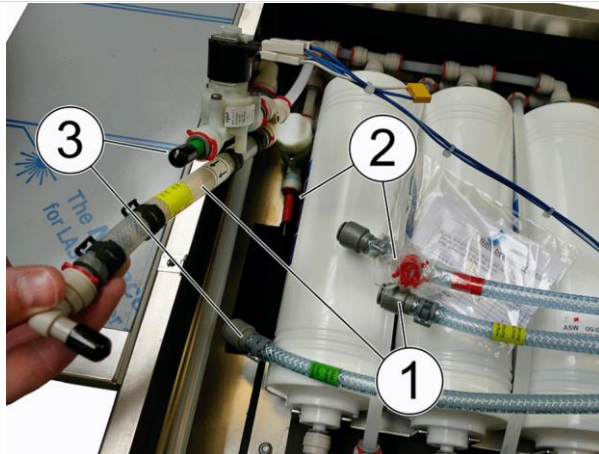

3. Connect the transparent fabric hoses for permeate recirculation (1), permeate (3) and concentrate (2) to the connections according to the colour coding and secure them with circlips.

4. Secure the fresh water supply line to the pre-filter with a spring band clamp and connect the bend plug connection.



5. Fit the circlips.

6. Connect the electrical connections.

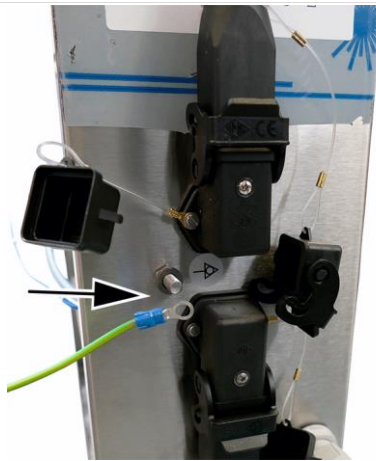

7. Connect the equipotential bonding.



8. Tighten the hoses from the outside and attach the cover.



9. Break out the holes in the base drip tray for the reinforcement profile (see picture).

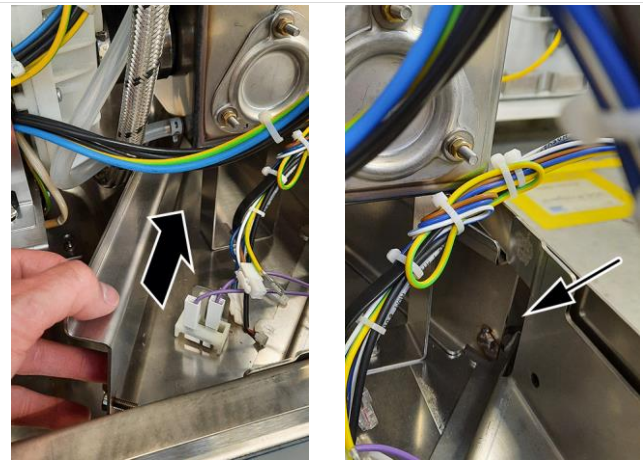

10. Insert the reinforcement profile from the inside into the base drip tray and insert the welded hexagon screws through the holes in the base drip tray.



11. Position the plinth and insert the hexagon screws through the holes in the plinth.



12. Screw the plinth with 2 washers and M6 self-locking nuts.

13. Attach the side panel of the machine. Retrofitting is not possible!



14. Place the GiO MODULE on the plinth and align it.

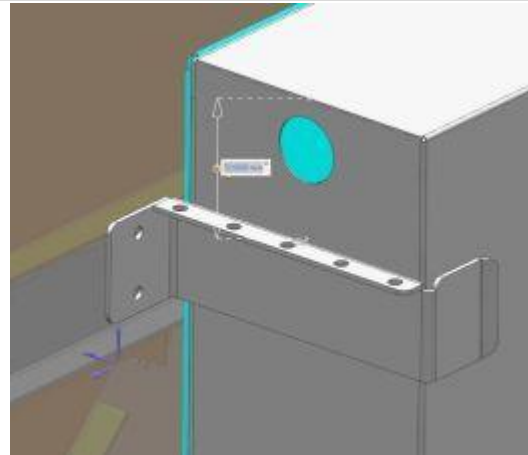

15. Position the holding bracket. Distance from the top edge of the GiO MODULE: 70 mm.

16. Drill out the holding bracket on the side wall.

17. Screw the holding bracket with M5 hexagon screws, washers and self-locking nuts.



18. Insert the filter element and screw in the pre-filter hand-tight.



19. Hook in the pre-filter casing and push it down.

20. Screw the casing together.

Freestanding assembly

1. Loosen the 6 screws of the cover of the GiO MODULE and carefully remove the cover. The protective conductor is mounted on the inside of the cover. Make sure that the cable is not damaged.

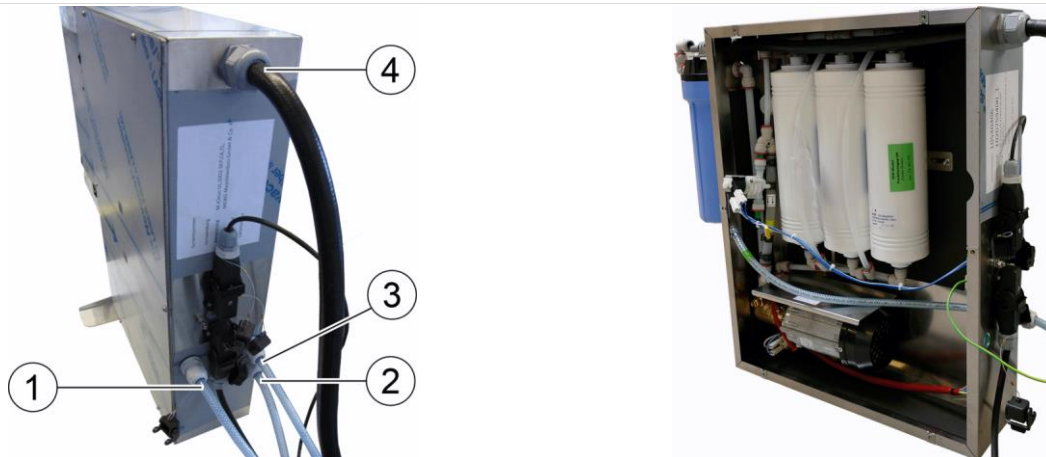

2. Guide the fresh water supply line (4) and the transparent fabric hoses for permeate recirculation (1), permeate (3) and concentrate (2) through the side opening in the casing.

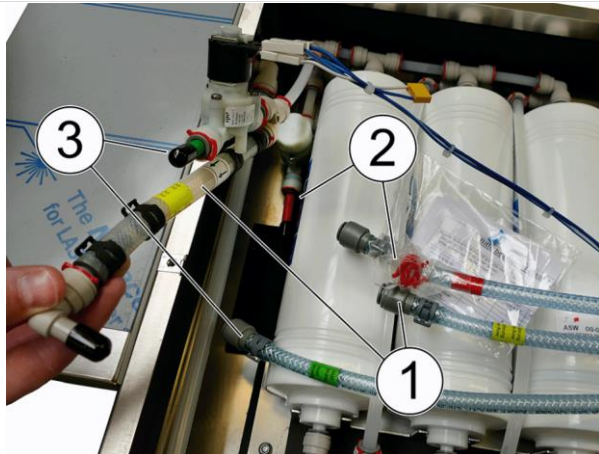

3. Connect the transparent fabric hoses for permeate recirculation (1), permeate (3) and concentrate (2) to the connections according to the colour coding and secure them with circlips.
4. Secure the fresh water supply line to the pre-filter with a spring band clamp and connect the bend plug connection.



5. Insert the circlips

6. Connect the electrical connections.

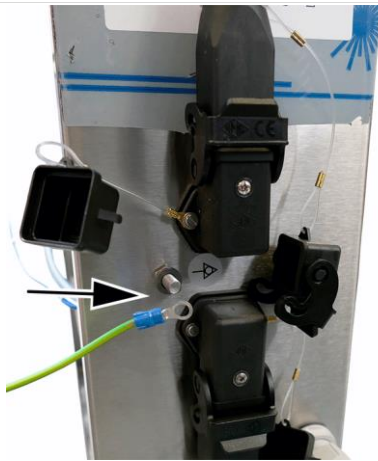

7. Connect the equipotential bonding.

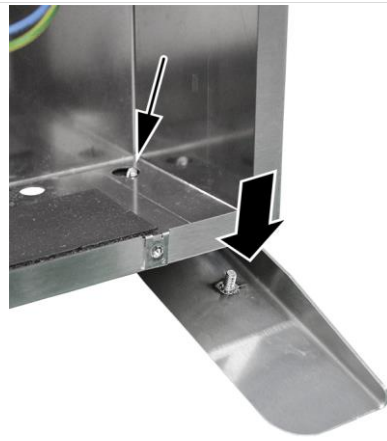

8. Place the GiO MODULE on the foot and insert the welded hexagon screws on the foot into the holes on the underside of the GiO MODULE.

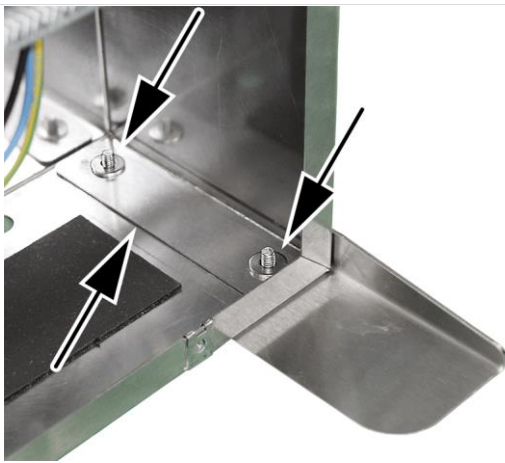

9. Place the perforated rail and the 2 washers on the hexagon screws.

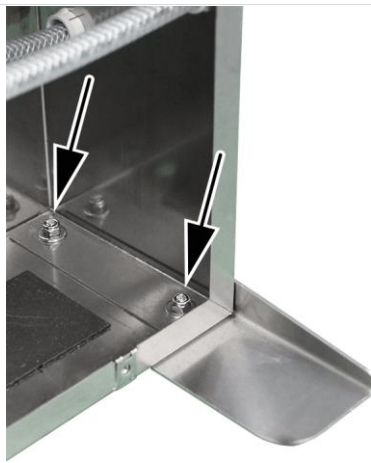

10. Screw the foot with 2 M6 safety nuts.



11. Tighten the hoses from the outside and attach the cover.
 12. Insert the filter element and screw in the pre-filter hand-tight.
 13. Hook in the pre-filter casing and push it down.
 14. Screw the casing together.

7.7 Connection

7.7.1 Connect waste-water line

1. Connect the drain hose to the on-site wastewater connection using a suitable drain fitting.

7.7.2 Connect fresh water line

Recommendation: Flush the on-site piping/shut-off valves and hoses before connecting the dishwashing machine. To do this, connect the hoses to the shut-off valves, open the valves carefully and collect the water in a bucket.

1. Check the hoses for damage.
2. Connect to the on-site shut-off valves.
3. Slowly open the shut-off valve and check that it is watertight. In the event of leaks, rectify the cause and check again that it is watertight.

7.7.3 Connect electrically

WARNING – Danger to life from electric shock

- Work on the electrical system must be conducted by a qualified electrician who complies with the electro-technical rules.
- Disconnect the machine from the power supply before working on the electrical system. To do this, turn the local mains switch to OFF and ensure that it cannot be switched back on again.

Connect the connection cable already connected to the dishwashing machine to the on-site junction box.

8 Commissioning

Once all connections are in place, request a service technician authorised by MEIKO for the handover.

This person must check the entire installation and carry out commissioning. Subsequently, the operating personnel is instructed on the basis of the handover protocol. The machine will then be signed over to your authorised representative.

9 Index

A

Assembly	13
Align machine feet	13
Connect dosing pipes	18
Connect external GiO MODULE	21
Fit AirConcept (heat recovery)	14
Install on a plinth	13
Install solid substance dosing	19

B

Building ventilation system	12
-----------------------------------	----

C

Checking the condition at delivery	5
Commissioning	27
Connection	27
electrical	27
fresh water line	27
waste-water line	27
Connection dimensions	7

D

Designation of machine type	3
Dimensional drawings	7
M-iClean PF-S Standard and solid substance dosing option	7
M-iClean PF-S with AirConcept (heat recovery)	8
M-iClean PF-S with GiO MODULE (optional)	9

I

Installation	10
--------------------	----

N

notes	3
Notices on use	3

P

Presentation conventions	3
--------------------------------	---

R

Requirements for the fresh water connection	
Requirements for the fresh water connection	11
Requirements for the waste water connection ...	12
Requirements to the electrical connection	10

S

Safety	4
Safety information, general	4
Safety symbols in the instructions	3

T

Technical data	6
----------------------	---

U

Unpacking	6
-----------------	---



The clean solution



MEIKO Maschinenbau GmbH & Co. KG

Englerstraße 3

77652 Offenburg

Germany

www.meiko-global.com

info@meiko-global.com

Design and construction subject to change without prior notice!